

432 AND ABOVE EME NEWS MARCH AND APRIL 2023 VOL 52 #2

EDITOR: AL KATZ, K2UYH; DEPT. ELECTRICAL/COMPUTER ENGINEERING, THE COLLEGE OF NEW JERSEY, PO BOX 7718 EWING, NJ 08628, TEL (W 609-584-8424), (C 609-947-3889), E-MAIL alkatz@tcnj.edu
ASSOCIATE EDITOR AND REFLECTOR/NETNEWS MATEJ PETRZILKA, OK1TEH, SIMUNKOVA 1609/21, 18200, PRAHA 8, CZECH REPUBLIC, TEL (+420 603 489 490), EMAIL ok1teh@seznam.cz
CW INITIAL LIST G4RGK, DAVID DIBLEY, E-MAIL zen70432@zen.co.uk, AT: <http://www.zen70432.zen.co.uk/Initials/index.html>
SUN & EXTRATERRESTRIAL NOISE LIST MANAGED BY OK1TEH: http://www.ok2kkw.com/next/nl_k2uyh/sun_table.xls
EME INFORMAL NETS: 14.345, ~1500 SATURDAY AND SUNDAY, NET COORDINATOR: OPEN
ON0EME EME BEACON, 1296.000 IS QRV WHEN MOON >10°, SEND RX REPORTS TO WALTER (ON4BCB) on4bcb@gmail.com
DL0SHF 3 & 1.2 CM EME BEACONS, 10368.025, 24048.025, SEND INFO & QUESTIONS TO PER (DK7LJ) per@per-dudek.de
EME DIRECTORY BY JAN, PA0PLY AT www.pa0ply.nl/directory.htm
NL EMAIL DISTRIBUTION and EMAIL LIST CORD: WARREN, W2WD wbutler@ieee.org
THE NL WEB VERSION IS PRODUCED BY REIN, W6SZ rein0zn@gmail.com, AT: <http://www.nitehawk.com/rasmit/em70cm.html>

CONDITIONS: It has been an extraordinary few months with so many contests and dpxpeditions going on that there never seems to be a time when there is not something happening off the Moon. The 13 cm DUBUS CW Contest generated the most interest with first time entrant **DL6SH** ending with the top score of 31x31. DB6NT and PA3DZL tied for 2nd place with 26x26. All are well above last year' top scores. The best 9 cm score is 16x14 from **G3LTF**, just above his top score last year of 15x15 (then tied with DB6NT). The 13 cm SSB Funtest appears another washout; however, **DL6SH** reports 4 SSB QSOs on 24 March. If Slewek submits a log, he could also be the chief 13 cm Funmaker for 2023. **The 70 cm DUBUS CW event did not draw as much attention as hoped, but still had a reasonable showing. G3LTF also has the top reported score there of 21x21.**

Coming right up is the BIG VK3UM Memorial 1296 DUBUS CW Contest on 22/23 April! This contest is one of the most popular of the year. Please try to be on even if you do not regularly operate CW. It is a challenge, but there should be no lack of stations trying. The 3 cm DUBUS weekend is 20/21 May.

March/April was not a great month for major dpxpeditions. N1V did an excellent job putting Hawaii on 1296 and 902 EME on 5-9 March – see Jays report in this newsletter (NL). The **SV5/DF2ZC/DF7FB** was cancelled. A nice surprise was that the **SY0S** dpxpedition to Sable Island scheduled for 20 to 29 March for 2 m, also brought equipment for 432 and was able to provide several 432 QSOs. Also, **YB2MDU** in Indonesia is now QRV on 70 cm and worked OK1KIR.

State dpxpedition activity continues by **KA6U** and others providing new States and new grids. Recent WAS successes are in no small measure due to efforts as these. **DK3WG** reported completing 1296 WAS this month. **NH6Y** is now permanently QRV from his home QTH in HI on 432 EME. **NX9O** is operating portable on 902 EME and is providing new States – see W5LUA's report.

We mourn G3LQR. G3LTF writes: Simon, passed away peacefully on 28 March. He started in EME on 432 in March 1975 building a 20' dish, which was destroyed in the hurricane of 1987. He then built a succession of

large, typically 8 bay, yagi arrays; all HB from designs by K2RIW and DL6WU; and was very active for a long time. 70 cm was always his favorite band. In March 1992 he put up a 14' dish, a professional mesh reflector, which had in fact been used in the 1960s for 2.5 GHz EME tests between ITT's site in NJ and the UK, and made his first contacts on 1296 with 100 W from a single 7289; later replaced by a 4 tube version. Simon loved the microwave bands and was very active on tropo, and in April 2001 made his first EME contacts on 13 cm and then in July 2007 on 9 cm and finally on 6 cm in July 2011, pushing the dish to its limits. His EME work inspired several of his locals to get on 23 cm EME themselves. He was a serious and dedicated home brewer of his equipment, often modified from something he had found at a scrap yard or a flea market. Sometimes his enclosures were not that extensive and so it was safest to keep your hands in your pockets when in his shack! His radio interests aside from EME were wide ranging, from transmitting TV in the 1960s to 3 cm rain scatter, 70 MHz (another favorite band), 28 MHz F2, 432 Aurora, 24 and 47 GHz, making many of the first contacts from 432 to 24 GHz with other EU countries. Simon was a kind and gentle man and many will have met him at some of the early EME conferences. He loved nature and was a great photographer in his last years of the butterflies on the farm where he lived. RIP old friend.



G3LTF's photo of Simon taken at Wurzburg in 2006. From left: Peter (G3LTF), Ivo (ZS6AXT), Simon (G3LQR) and Karl (SM3AKW). They have worked each other many times on EME throughout the years.

4X1AJ: Andey andybezh@gmail.com writes about his 10 GHz EME RX experiments with *cheap equipment* -- After looking at KA1GT webpage https://www.bobatkins.com/radio/10Ghz_EME_rx.html, I tried to receive the DL0SHF beacon with a 1.2 m motorized satellite dish and LNB. The Sun noise was around 12 dB. Unexpectedly, I had no success with the GPSDO LNB; probably due to poor LO phase noise. Disconnecting GPSDO solved the problem at once. The best DL0SHF level was (6dB). I also heard OZ1LPR (56A) on CW and (11dB) on QRA65D, and OK1KIR (17DB) QRA65D. The dish was aimed with a Raspberry Zero camera. I hope to be QRV on 3 cm TX in the near future, but there is a lot to do.

CX1AA: Rick (CX2SC) cx2sc.base@gmail.com reports that Radio Club Uruguayo (GF15) was active on 23 cm EME on 18/19 March to celebrate its 90th anniversary - I am also giving talks on EME and the demonstration with the intention of motivating moonbounce in the region. [We do not yet have any final report on the success of this event].

DB6NT: Michael db6nt@gmx.de sends news on his EME in March and April – On the weekends 4/5 March I was QRV in the DUBUS 9 cm Contest. The weather (WX) conditions were bad with rain and snow; but I was still able to work using CW OH2DG, OK1KIR, DF3RU, PA3DZL, G4CCH, DL6SH, ES5PC, SP3XBO and G3LTF for a total 9x9. Last year I made 6 more QSOs, but I was also a few less hours this time. Then, later in the month, I was active in the 13 cm DUBUS Contest on 25/26 March. The WX conditions were again bad with rain and snow. Despite the poor WX, I was able to work on 13 cm using CW and SSB JJ1NNJ, OK1KKD, PA3DZL, HB9Q, OZ5G, UA5Y, DF3RU, DL4DTU, IK3COJ, SP7DCS, G3LTF, ES5PC, K3WM, K2UYH, DL6SH, OH1LRY, PA0PLY, SP3XBO, WA6PY, KL6M, 9A5AA, VE6BGA, OH2DG, ON4BCB on SSB, W5LUA and G4CCH for a total 26x26. In 2021, I had 7 fewer QSOs. On 1/2 of April, I was also QRV for the **ARI Contest on 10 GHz** for a few hours. The WX was again terrible with rain and snow – some year! I QSO'd on 3 cm CW OK1KIR, HB9BBD, OK1CA, DK4RC, OZ1LPR, DL4DTU, SM4DHN, OK2AQ and IW2FZR for a total of 9 stations.

DK3WG: Jurg dk3wg@dark.de (JO72gi) sends info on his initials in March, which **included completing 1296 WAS - congratulations!** – On 70 cm I added using Q65B KA6U in both grids EM56 and EM57 and K5DNL; and on 23 cm using Q65C N0LNO, N0AKC, **N1V in Hi for a new DXCC and his 50th State for 1296 WAS** and KA6U in EM57.

DL6SH: Slawek dl6sh-eme@online.de has expanded his system and done super well the past few months -- I was quite active during winter time and added 3 new bands to my EME station (13, 9 and 6 cm). I am using my 8 m mesh dish from 144 up to 5760. At 6 cm I have lower efficiency. I can only operate one band at a time. My 2023 EME season started with the 23 cm SSB

Funtest. I made 24 SSB and 2 CW QSOs during the contest period – [reported on in the last NL]. I was next active in the DUBUS 9 cm Contest on 4/5 March. I had to spend most of my bedtime to make 14 CW QSOs and 13 mults. This date was very bad for me due its conflict with the EU Tropo Contest. I was able to be active in both. I worked on 9 cm OK1KIR, G4CCH, DB6NT, PA3DZL, ES5PC, G3LTF, OH2DG, OK1CA, DF3RU, VE6TA, K2UYH, WA6PY, SP3XBO and 9A5AA. As too tired, I did not catch VE6BGT. **During the 13 cm SSB Funtest on 24 March I made 4 SSB and 5 CW QSO.** In the 13 cm DUBUS CW Contest, the date was much better, and I ended with 31 QSOs and 31 mults. I worked IK3COJ, OK1KKD, IW2FZR, PA0PLY, DB6NT, K3WM, KL6M, JJ3NNJ, PA3DZL, HB9Q, UA5Y, OM6AA, DL1SUZ, DL4DTU, SP7DCS, DF3RU, OH1LRY, 9A5AA, IK2RTI, SP3XBO, ES5PC, WA6PY, G4CCH, OZ5G, OK2ULQ, JA6XED, JA8ERE, W5LUA, PE1LWT, VE6BGT and K2UYH. I missed G3LTF in the contest, but worked Peter later. At 9 cm I am using RA3AQ feed, G4DDK preamp with NF = 0.4 dB and a LZ5HP transverter to 432. For TX I am using a 75 W SSPA. For 13 cm I am using a RA3AQ feed too; G4DDK preamp with 0.35 dB NF and a 75 W SSPA. On 6 cm I have a RA3AQ feed with 1.1 dB NF DG0VE preamp and an old transverter from SP9QZO (SK) down to 144 with GPS loc. A better preamp is ordered. On TX I am using a SM6PGP 50 W SSPA. My dish is working super up to 9 cm, but at 6 cm with low efficiency only, but I can hear my weak echo there. I tried my mesh dish at 10 GHz for fun, but with very low gain only. It is good for QO-100 DATV or satellite TV only. For the future, I am starting to prepare a 2.4 m offset dish for 3 and 6 cm. At 144 I am using a homemade OK1DFC loop feed, 0.5 dB NF preamp and a Italab SSPA with 750 W at the feed. On 432 I am using a OK1DFC loop feed, 0.5 dB NF preamp and a Italab SSPA with 750 W at the feed. On 1296 I am using a OK1DFC septum feed, G4DDK 0.25 dB NF LNA and a Labetech SSPA with 500 W directly behind the feed. I am always using 4 receivers at the same time; ICOM IC 275, IC 475 or IC 1275, Perseus-SDR with converters, FunCube Dongle for MAP65 and a RTL-Stick for measurement of noise with *TotalPower* from I0NAA. As a splitter I have a MiniCircuits ZN4PD1-63W-S+, which I found usable from 144 to 1296.



DL6SH's 8 m mesh dish with 6 cm feed

G3LTF: Peter's g3lft@btinternet.com EME report for Feb/March/April follows – I was active on 4 bands, 70 thru 9 cm; all QSOs CW or SSB and included 7 initials added. On 24 Feb I was checking out my 432 system and had a nice CW chat with DL9KR. **In the 70 cm DUBUS-REF Contest**, I worked on 25 Feb, OZ4MM, PA5Y, DL6SH, OK1DFC, PA3DZL, G4RGK, DL4DTU, SM6FHZ, OH2DG, OH1LRY, OE5JFL, DF3RU, PA2V, K2UYH, VE6TA, W5LUYA and KL6M, and on 26 Feb, OE3JPC, DG5CST, UA3PTW and WA6PY for **a total of 21x21**. Faraday was 90 deg for much of the time. Sun noise 17.6 dB with SF 148 on 24 Feb. On 27 Feb I put the 23 cm feed in the dish and worked VK2JDS for initial #532 and LA1TN #533. The next weekend was the **9 cm DUBUS-REF Contest**; on 4 March I worked OH2DG, KL6M, WA6PY, 9A5AA, K2UYH, VE6BGT, OK1KIR, ES5PC, G4CCH, OK1CA, DF3RU, PA3DZL, DL6SH for initial #77 and VE6TA, and on 5 March SP3XBO, DB6NT, PA3DZL and DF3RU – these last two DUPs worked on SSB just for fun! **My total was 16x14**; a long way down on the peak of a few years ago due to several countries losing the band, but I would have expected more US activity. 95% of the signals were (579); it's a great band for EME. Sun noise was 17.4 dB at SF180. **The 13 cm SSB Funtest was a complete wipe-out here**. There were very strong winds, which continued until 1600 on 25 March, when I was able to work UA5Y, OH1LRY, OK1KKD, DB6NT, DF3RU, IK3COJ, DL4DTU and K2UYH. Then at 1800 the PA failed! By the time I had it working again on Sunday it was too late to put it back up at the dish. But on 27 March, I did work PA0PLY, DL6SH for initial #158, G4CCH, IW2FZR #159 and PA3DZL on CW and SSB; and then on 28 March ON4BCB #160 with a big (589) signal. I ended the **DUBUS 13 cm Contest with a score of only 8x8**. with Sun noise was 21.1 dB with a SF158. Next, I was on 23 cm **for the ARI Contest** where I QSO'd on 1 April DG5CST, IK1FJI, SP6ITF, IQ2DB, DE3RU, DL1AT, PA3FXB, SM6CKU, G4CCH and GOLBK, and on 2 April IK2DDR, IK5VLS, LA1TN, SP7EXY, F6KRK and AA4MD #534 for a total of **17 QSOs**. Activity was a bit lower than I expected. The TX mixer in my 13 cm transverter, a varactor upconverter with 0.5 W LO pump built in about 1972 has failed and I am replacing it with a more modern (!) arrangement, which should also allow operation at 2300.

G4RFR: Julian (G3YGF) Julian@ygf.org.uk and G0API report on the G4RFR EME Group's 3 cm EME operation – In Feb/March we had about 33 QSOs in 8 sessions, including CW and SSB with OZ1LPR, and CW with DG5CST, DL4DTU, HB9BBD, SA6BUN and IK0HWJ. We were heard by IN3ER on a 50 cm dish and G4HSK at (6DB). We also had a good 2-way SSB QSO with W7CJO, who was our second EME QSO in 1994. We have now setup for cross-frequency working, and were rewarded by QSOs with JA4BLC, JA8ERE and JA1WQF on CW on 10368/10450. We were also heard by BG6LQV. We are regularly active off the Moon and are looking for QSOs and schedules to any one or two-way exchanges and can usually work stations running as little as 10 W to a 1.2 m dish. If you can hear us, try

calling! We will be monitoring HB9Q when active. [Analysis of their 3 cm reports toward the end of this NL, and article about their station at http://www.g4jnt.com/FRARS_EME/FRARS_EME_12.pdf.

G4BAO: John john@g4bao.com writes on his 3 and 1.25 cm efforts -- After a 6 month hiatus since ordering it, and trying to get a new Kuhne MKU10G5 transverter working properly (the firmware seems to have serious), I'm now QRV on 3 cm again and looking for my first CW and JA contacts on the band. I am running 20 W to 1.2 m offset dish. Progress toward 24 GHz activity is slow, but I feel I've broken the back of the major issues holding me up on this band. I am now hoping for my first QSO soon.

G4RGK: Dave's zen70432@zen.co.uk NL report for the DUBUS 432 CW EME Contest -- The winter in the UK has kept me away from EME. So far this year, I did find time **to get on 432 for the DUBUS 70 cm Contest**. On Saturday I was only able to get on for the second pass. My polarization seemed to be very favorable to EU but very difficult for the NA stations. I worked DL6SH, G3LTF, OK1DFC, OH2DG, OE5JFL, PA5Y, SM6FHZ, DF3RU, VE6TA and WA6PY once again with his single yagi – very pleased. On Sunday due to a prior commitment, I was only able to spend a short amount of time on the band. I worked UA3PTW and K2UYH. I missed another four or five stations, who I never found calling on CW. **I ended with a score of 12x12**.

IK1FJI: Valter valter_dls@yahoo.it reports of his recent 1296 activity -- Not a great amount of EME here, but I was **QRV in ARI Contest** for 4 hours on Saturday 1 April and only 1 hour due to high wind on Sunday. **I worked 25 CW stations and one on SSB**; no digital in any contest here. **I was very pleased with my result in ARRL EME Contest on 23 cm CW only**. I plan to be QRV for the DUBUS 23 cm Contest but only on Sunday 23 April because of a conflict Saturday with the annual Italian EME meeting!

IK3COJ: Aldo aldo@ik3coj.it **sends news that he has completed DXCC on 1296!** -- Feb was a truly great month for me. After having **completed QSOs with the two dxpeditions to JD1 and PJ2**, I was able to complete a sked with ZL1NJR; and get in one fell swoop another new one on the 23 cm band for my 100th country. This was the first ever 1296 QSO between I and ZL, and the result of my more than 30 years of EME activity. I had attempted a QSO last year, but Nathan was too weak with only 12 W at the time. On this last occasion, we had a very short window (30-35 mins) and a very low Moon, only at 3-4 degs of el at both ends. However, the QSO occurred fast and was easily completed.

K7ULS: Mike k7uls@yahoo.com was **QRV on 432 during the weekend 25/26 Feb** – I had two FB initial QSOs using my single M2-432-9wL yagi and 250 W with PA3DZL and W2HRO using Q65B. The QSO with Paul took a very long time and I almost gave up but am glad

we stuck it out as we've tried many times before with no luck. In the end I added 1 new DXCC and one new state.

K8ZR: Tony WA8RJF@ARRL.net sends info on his recent EME Activity -- Since my last report, I have worked 30 stations all on 1296 using Q65C. Initials were UA4LCF for a mixed initial (*), SM7FWZ (*), N0AKC (*), KA6U in EM55 (*), EA8DBM (*), N0LNO (*), NX9O(*), N1V (*), CX1AA (*) and IK5VLS (*). To date: 45 CW initials and 80 digi initials. [Expect Tony to be QRV for the DUBUS 1296 EME CW Contest].

KH0/KC0W: Tom cqdx4@aol.com brings us up to date on his plans -- I'm currently exploring the possibility of also getting on 13 cm EME (in addition to 1296). I plan to run 120 W on 13 cm if I decide to get on it. In the meantime, my goal is to help the guys with a KH0 QSO on 23 cm when I go QRV. The only callsign I will be using on EME will be KH0W. I will not be using KH0/KC0W due to past issues I've had regarding *stroked* callsigns. Sometimes the stroke creates problems with WSJT. On moonrise I can see the Moon at roughly 8 degs. I can then clearly track it all the way to zero degrees as the Moon sets directly into the ocean. When I first go QRV, I will be positioning the dish by hand. This will probably change to a full AZ/EL system in the future. My setup for 23 cm is a 2.4 m folding dish and 230 W at the feed. I travel to Guam (KH2 land) once a month. I have spoken to an amateur friend on Guam to help me secure a good EME location for the possibility of being QRV while on Guam sometime. It appears neither KH0 or KH2 have been on 23 cm EME before. [We believe KH2 may have been on, but need to check]. My work hours consist of either 8 AM – 4 PM, 4 PM - midnight or midnight - 8 AM. According to EME prediction software my window of opportunity with EU is quite long. I'm willing to host anyone if they ever find themselves coming to Saipan. My main love in amateur radio is CW. I'm looking forward to working other CW enthusiasts off the Moon. [You will not have a problem finding CW ops].

KNOWS: Carl carlhasbargen@q.com is a new grandfather! -- Although my schedule was a bit uncertain with my new grandchild in town, and in spite of predicted bad WX, I did set up for 23 cm activity on the ARI weekend from my backyard. On 31 March before the start of contest, I worked using Q65C N0CTR (20DB) and KB2SA (19DB). In the contest using Q65C on 1 April, I worked IQ2DB (20DB), K2UYH (16DB), PA3FXB (23DB), W5AFY (21DB) and N5BF (23DB). I quit early because we were having a snow blizzard and I already had 6" of new snow on the dish. The next morning was sunny, but there was a total of about 8 inches of new snow on the ground. Nevertheless, on 2 April, I worked DF3RU (14DB), IK5VLS (21DB), N0CTR (18DB), K5DOG (20DB), KD5FZX (11DB) and LU8ENU (23DB) for a total of 11 QSOs. All of my QSO's were using Q65C, except I used Q65-30B for KB2SA. It was good to get my first EME QSO's of 2022, but I found surprisingly few stations on the 23 cm band during my late windows. If future spring ARI contests are in late April or May again, I will be able to go north to my larger

dish for an extra 6 dB of gain each way and with a 12 hour moon windows instead of the 4 hour windows I have from my back yard. [Please note that Carl's northern QTH is in a different grid, so you should be able to get 2 initials from him].

LZ1DX: Ned lz1dx@lz1dx.org reports on his 1296 Funtest results – I worked on 28 Jan SM6CKU (57/57) JO SSB 1-1, RA3EME (579/569) CW -, DL6SH (57/56) JN SSB 2-2, OK2DL (58/57) JN SSB 3-, DG5CST (58/57) JO SSB 4-, XE1XA (55/57) EK SSB 5-3, DF3RU (57/57) JN SSB 6-, LX1DB (57/55) JN SSB 7-, WA6PY (579/569) CW -, K2UYH (57/55) FN SSB 8-4, VE6TA (579/579) CW -, IK1FJI (57/58) JN SSB 9-, PA0PLY (57/57) JO SSB 10-, G3LTF (57/57) IO SSB 11-5, G4CCH (57/58) IO SSB 12-, SP3XBO (559/559) JO CW -, I1NDP (57/58) JN SSB 13-, 1458 DL1SUZ (579/579) CW -, DL7UDA (55/57) JO 14-, IK2DDR (559/579) JN CW -, and OK2PE (559/579) -; for a total of 14x2x5x100 = 14,000 points. [More reports can be found in the last NL].

N1V: Jay (N1AV) whereisjay@gmail.com reports on his expedition to Hawaii with W2HRO -- The Hawaii KH6 N1V Unfinished Business tour is now complete. It was a joy to give HI as State #50 to 4 stations. The trip went well, but not without incident. A full blog writeup is here: <https://www.n1rvy.org/?p=925>. Stations worked using Q65C unless noted on 1296 were K5QE (22DB/19DB) EM31 for 1296 WAS; K7EME (31DB/23DB) DM42; PA0PLY (22DB/20DB) JO32; W7JW (25DB/22DB) for 1296 WAS; N9HF (23DB/22DB); EA8DBM (22DB/22DB) IL18; N9LHS (22DB/22DB); N0LNO (21DB/20DB); AC0RA (21DB/20DB); WH6A (23DB/22DB); W5GLD (21DB/21DB) EM15; KD5FZX (15DB/15DB) EM12; W6TCP (27DB/22DB) CM97; KB2SA (21DB/22DB) CM97; VE6TA (18DB/15DB) DO33; KB2SA Q65-30D (20DB/23DB); W7JW Q65-30D (24DB/22DB); SM6CKU JO67 (5DB/15DB); W2ZQ (24DB/19DB) FN20; IK3COJ (22DB/15DB); DK3WG (23DB/21DB) JO72 for 1296 WAS; W5AFY (24DB/19DB); N0CTR (20DB/20DB) EN26; W5LUA (18DB/15DB) EM13; AA6I (24DB/24DB); N5BF (24DB/22DB); K5QE (19DB/20DB); K8ZR (25DB/20DB) EN91; N0AKC (24DB/25DB) EN44; KB2SA (20DB/20DB); VK2JDS MFSK (18DB/18DB) QF46; OK1IL (25DB/27DB) JN69 for 1296 WAS; DG0FE (18DB/20DB); IQ2DB (20DB/26DB) JN45; KA1GT (20DB/19DB); VE3NXK (27DB/24DB) FN05; VE3KRP (24DB/18 DB) EN58; and N5TM (25DB/23DB) EL29; and on 902 were AC0RA (23DB/24DB) 1st IA to HI EN42; K0DAS (23EDB/24DB) EN42, KC0TYD (25DB/30DB) EN42; KC0SKM (24DB/30DB) EN42; N0LNO (24DB/27DB) EN42; K5DOG (24DB/21DB) EM00, VE6TA (19DB/17DB) DO33; W5LUA (21DB/21DB) EM13; and WA3RGQ (23DB/27DB) 1st FL to HI EL98. Planning is underway to return to HI 2024. The "Band Blowout Event" in 2024. It will be the last time I bring 1296 and 902 to Hawaii for a while. Currently planning a joint trip with W2HRO and 4 bands for EME (902, 1296, 2304 and 10G). More information on dates will come this summer. It is looking to be March in 2024 for the longest

EU window. I was excited to have seen the results of the 2022 ARRL EME contest and my SO-AMAB #2 World score; especially considering I only operated 144/222/432 and 1296. I am working hard this spring and summer to get 2304, 3.4, 5 and 10 GHz operational off the Moon from home; so I can take advantage of the first two weekends of the 2023 Contest this fall. Expect a lot of sked requests as I get new bands on the air.

N5BF: Courtney courtney.duncan.n5bf@gmail.com clarifies his 1296 WAS situation reported on in his last report -- K1EEP was my 43 State confirmed, not the completion of WAS. [Really our error]. My WAS on 1296 is mixed, some CW but mostly digital. I'll correct all this in next month's report. What was interesting and I did not notice until I was doing my QSL cards is that NOOY, who I talked about at length as a SKN (Straight Key Night) QSO was also a new State that I needed, Kansas. So now I have 44/50. All of the States that I have worked are also confirmed (somehow), so I'm getting close. I had missed KA6U's Kansas activity because he moved the station down into OK before I had moonrise here. If I manage to work KA6U in MS and LA, I should be at 46/50 but these are going to be tight; and I have conflicts on those days. I have Alabama from KB7Q. What is the most surprising holdout so far is Utah. Others are ND, OR, and NH.

NC1I: Frank frank@NC1I.COM has not been very active the last few months -- I spent most of Jan to early April in Florida, so I had very few opportunities to be QRV. And, I still have not completed setting my station up for remote operation. That is now a priority. Initials worked in 2023 on 23 cm include KA6U in NM (DM85), **PJ2T (a new DXCC!)**, and CX1AA (I am assuming that this loc is different than Ric's home station) to bring my mixed initial total on 1296 to #489*. Initials worked in 2023 on 70 cm include KA6U in NM (DM85), JA6UJS in PL24 with 4 x 20 el yagis and 500 W, **CY0S for DXCC #98** (once confirmed) - they peaked at (24DB) but strong wind at their location was causing much QSB, LZ4FR (no info), ON7EQ with 2 x 20 el yagis and 200 W, N3BYR in EM82 with a single 15 el yagi and 80 W. These brings my digital initial total on 70 cm to #559. I'm planning to be active on 23 cm CW during the DUBUS Contest.



The Microwave Update Conference was held in CT this April close to NC1I's QTH. Shown L-R are VE4MA, NC1I, K8ZR, and W5LUA visiting Frank's Antenna Farm. "It was a great time!"

ON5GS: Dirk dirk.reyners@telenet.be reports on the ARI EME Contest -- On Sunday evening 2 April, I gave out some ARI Contest points on 23 cm EME. I started on CW by working DG5CST, G4CCH, G0LBK, DF3RU and IQ2DB. I then switched to Q65C to QSO PA3HDG, IK2DDR, SM6CKU, OK1USW, KA1GT, PA3FXB, IQ2DB, RA4HL, IK5VLS, IU4MES and G7TZZ. 5 CW and 11 digi contacts were made for a total 16 QSOs.

OK1CA: Franta fr.strihavka@seznam.cz sends news on his ARI Contest results -- I was QRV in the spring part of the ARI EME Contest on the 3 cm band. I made a total of 24 QSOs of which 7 were CW with stations - OK1KIR, HB9BBD, DB6NT, OZ1LPR, OK2AQ, SM4DHN and HB9BHU. Other QSOs were by Q65D and yield digi initials with DK4RC (#82) and IU0BTM (#83). I found that operating with both modes can make the contest interesting. There was high activity from Italy; I worked 6 stations and also tried to connect with IW3ROW, but he had decoding problems. Mainly EU stations took part in the Contest only VK7ZBX and CX2SC were QRV outside of EU on 10 GHz. There was no activity at all from NA.

OK1KIR: Vlada [vlada.masek\(x\)volny.cz](mailto:vlada.masek(x)volny.cz) and Tonda's send news on their Feb-Mar EME -- During DUBUS Contest weekend on 70 cm we contacted using Q65B on Saturday 25 Feb at 1043 **BV3CE (14DB/16DB)** for mixed initial #685*, 1222 R50EME (32DB/13DB) with huge local QRM, 1241 PA3FWV (12DB/16DB) #686*, 1252 GM0HBK (22DB/17DB), 1301 PA3DZL/p (20DB/17DB) as a QRP test, 1312 SQ9CYD (13DB/11DB), 1322 DJ8MS (19DB/18DB) and 1522 M0CTP (21DB/21DB) #687*; and the next day on Sunday, 26 Feb at 0946 VK3NX (22DB/21DB) #688* - Charlie became our 10th station worked on 7 bands (432 thru 24 GHz)! - 1203 OE3JPC (16DB/15DB) #689*, 1235 JF6CTK (20DB/17DB) #690* with only 30 W, 1317 JH7OPT (18DB/21DB), 1325 HG5BMU (19DB/17DB), 1332 JS6USJ (22DB/15DB) #691*, 1405 OK2AQ (23DB/22DB) and 1415 GW4ZHI (19DB/18DB) #692*. We QSO'd on Friday, 3 March when testing our 9 cm rig before the DUBUS Contest on CW at 1720 DL6SH (589/579) for mixed initial #100*, on Saturday, 4 March in the contest at 1527 OH2DG (579/579), 1533 OK1CA (579/579), 1630 G3LTF (569/569), 1702 G4CCH (579/579), 1713 DF3RU (569/569), 1802 ES5PC (579/579), 1854 9A5AA (O/O), 1923 DB6NT (579/569) #101*, 2032 PA3DZL (559/569) and 2105 DL6SH (579/569); then switch to Q65C (out of contest) at 1615 OZ5G (3DB/6DB). On Sunday, 5 March we switched to 70 cm to try with YB2MDU, but rain in YB ruined the sked. However, on Monday, 6 March we succeeded using Q65B at 2011 YB2MDU (24DB/23DB) #693* and new DXCC 131. Already during the sked with YB2, we suffered from sudden interrupts of the dish steering system. Later on 24 March when trying to find CY0S traces in noise background, the dish steering stopped completely and all fixes made failed. During next several days we went through a thorough inspection of the old F1EHN steering system. It had been in operation for 21 years. Hopefully we have now returned it to operation.

We were therefore able to operate in ARI Contest on 3 cm. We worked on Saturday, 1 April at 1344 OK1CA (569/579), 1418 HB9BBD (579/579), 1456 DB6NT (579/579) and 1802 OZ1LPR (589/569) - huge signal from Peter. Somebody else called us, but we were unable to dig the call due to too much spreading. Later with Q65D, we worked at 1248 VK7ZBX (13DB/7DB), 1331 OK1CA (7DB/6DB), 1357 OK2AQ (11DB/10DB), 1511 DK4RC (3DB/3DB) for mixed initial #319*, 1516 LZ4OC (14DB/7DB), 1719 IU0BTM (14DB/7DB), 1739 OZ1LPR (+3DB(!)/5DB), 1855 IZ2DJP (11DB/8DB) and 1927 IW2FZR (10DB/7DB) for a total on CW of 4 and on digi 9. We also heard by VK4WYM (17DB) with a 1.2 m offset dish, by 4X1AJ (16DB) with 1.1 m dish and by CT2GUR (8DB) with 2.3 m dish. We continued operation in next days and worked on Tuesday, 4 April using Q65D at 2043 CT2GUR (18DB/12DB) #320*, 2048 IZ4BFA (12DB/8DB), 2100 I4TTZ (13DB/12DB) and 2128 IZ2DJP (16DB/9DB). All QSOs we made at high spreading, over 200 Hz, and later at spreading even close to 250 Hz (maximum as predicted by Moonsked). We tested our own echoes on WSJTX. It was interesting to observe the quite narrow spectrum of the real echoes on 3 cm, allowing digital mode operation.

OK1IL: Ivan ivan@kaimann.cz sent us the following email regarding his fight for his 23 cm WAS diploma! "I haven't had such a nervous breakdown on EME for a long time". The first two days N1V had the CFOM set wrong, so with 5 dB background noise from the trees and ground, I couldn't see his Q65 trace. The very last window on 8 March after Jay reset his PC, I finally detected him where he was supposed to be. The WSJT-X auto sequencing during Deep Averaging seemed pretty dumb as it decodes only deep into the next TX period. I was operating remotely from Prague... and my heart was *knocking* wildly due to my fear of losing the Internet. "Days before, I was not sure when I would be allowed to go home from the cardiology unit" as on 1 March they had installed a pacemaker. Fortunately, on 2 March they let me go home. I was supposedly in trouble; it could have stopped completely. There was no future in hanging around under the antenna near the power. I was sweating profusely when the red line popped up, and then waiting for the next one with RRR. I've already contacted MP to see when I'll be able to arrive with two paper QSL's, I have 48 confirmed on LotW. Such is the life of a lunatic, as Zdenek DFC correctly calls us."

OK1VUM: Mila ok1kze.com wrote about his 70 cm EME on 25/26 Feb -- I took advantage of the EME activity generated by the CW Contest to test my remote control of EME station. Due to the fact that I do not have a CW remote set up, I only transmitted using Q65B. I didn't call all the time; I had other things to do besides listening. Occasionally I couldn't listen due to the snow and occasionally had to park the antenna due to the wind. The remote-control worked pretty well. I wasn't in the club once, all weekend. Everything worked properly. I made contacts with DL7APV, VK2CMP, R50EME,

OK2AQ, BV3CE, VK4EME, EA5CJ, SQ9CYD, OH3AWW, YO8RHI, DJ8MS, JH7OPT, PA3DZL, ES3RF, DL4DTU, DK0TE, JS6UJS, DF3RU, PA0BAT, YO5TP, GM0HBK, F6GRB, DL5FN, PA2V, W5LUA, N0AKC, K5DOG, N9XG, NN3Y, S51ZO, K2UYH, VP8EME, UA3PTW, JE1TNL, OE3JPC and HG5BMU. On Sunday morning I visited OK1DAI at OK1KIR's EME site to see how they do it! G3YEG contacted me that he decoded my signal with one antenna located in his attic (under the roof)! He immediately put it on his QRZ.com profile. The weekend's operation yielded a number of insights into what needs to be improved; so there will be work for me to do. To give you an idea of how the (6DB) digi EME signal is heard by ear with SSB filter. It's not the strongest signal on the band, but I was able to record a hearable signal on the band, but I was able to record a hearable signal. UA3PTW uses an antenna a bit larger than mine, 32 x 15 el yagis, and 1.5 kW power. If I hear it at (6DB), I have at least 20 dB of margin; so it should be possible to decode it even if he had 10 W. Some photos of my station can be found at <https://www.ok1kze.com/galerie/klubove-akce/stavba-velke-70cm-anteny>.

OK2AQ: Mirek mirek@kasals.com reports first on the 432 part of the EU CW EME Contest organized by DUBUS and then on the ARI Contest that he operated on 3 GHz -- 25-26 Feb brought a significantly increased in 70 cm activity not only by CW, but also by digi stations. Conditions were average with around a 2 dB degradation. With only a single long (8 WL) X-yagi in an urban environment, I tried listening to CW stations, but it was miserable. In contrast, the Q65 ran quite decently and I enjoyed the comforts of home while doing so. It turned out again that the possibility to work with both polarizations is a big advantage on 70 cm. I made 14 QSOs with three digital initials from OK1DFC (12DB/32DB), OK1VUM (25DB/24DB) {#52}, DL7APV (12DB/15DB), DF3RU (20DB/22DB), DG5CST (15DB/22DB), UA3PTW (19DB/28DB), VK4EME (28DB/22DB), HB9Q (16DB/19DB), PA3DZL (23DB/23DB), DK3WG (20DB/24DB), OK1KIR (22DB/23DB), PA0BAT (32DB/27DB) {#53}, R50EME (23DB/25DB) and N9XG (22DB/26DB) {#54}. My TX power was 300 W with a 0.5 dB NF LNA. I was next on for the ARI Contest. There was cold WX with occasional rain and snow showers in the morning; The Moon declination was high. I operated from my rural QTH on 1-2 April, on the 3 cm band. The activity was quite decent, but stations from the USA and Japan were missing. In preparation, I did a QSO to Tasmania on Wednesday with VK7ZBX (23DB/19DB) and two crossband CW QSOs with JA4BLC (O/O) {#129} and JA1WQF (O/O) on Thursday. In the contest, I made 21 QSOs of which 6 were CW, the others were Q65D or E. Contacted using digi unless noted were VK7ZBX (20DB/18DB), OK1KIR (10DB/11DB), OK1CA (12DB/11DB), OK1KIR (O/O), HB9BBD (559/549), DK4RC (14DB/12DB) for digital initial {#130}, IW2FZR (15DB/15DB), LZ4OC (22DB/15DB), IU0BTM (16DB/21DB), I4TTZ (18DB/18DB), OZ1LPR (2DB/13DB), on CW OZ1LPR (569/529), CX2SC (20DB/17DB), G4BAO (19DB/21DB), on CW OK1CA (559/559), G0OLX (21DB/14DB), PA0BAT (11DB/11DB), on CW SM4DHN

(579/549) {#131}, IK6CAK (14DB/15DB), on CW DB6NT (559/559) and IZ2DJP (16DB/16DB). With a very large spread, it is advantageous to use the Q65E, which was confirmed when connecting with G4BAO. I have a good overall impression of the contest. It's a pity that the QSO with G17UGV was not successful, but there must be a physical limit somewhere and at least I have something to look forward to the next time.

OK2ULQ: Peter ok2ulq@seznam.cz was QRV 23 cm during the Feb SSB FUNTEST only on Saturday night and only for a few hours -- I worked 9 QSOs with DG5CST, DL6SH, DF3RU, G3LTF, SA6BUN, SM6CKU, OK2DL, OZ6OL and LX1DB all on SSB. Later using Q65C, I added SP5GDM, KD5FZX for a digital initial {#}, W2ZQ, RA2FGG and K8ZR {#}. In March, I joined in the DUBUS 13 cm CW Contest. My participation in the contest took place on Sunday. Unfortunately, I didn't make it to sunset. There weren't many stations on the band, so I finished earlier than planned. I did manage to contact PA3DZL, ES5PC, KL6M, OK1KKD and OH1LRY for a total of 5x5. I also had QSOs for the first time on 13 cm [using digital?] with IW2FZR and DL6SH.

ON4BCB: Walter on4bcb@gmail.com is now QRV on 13 cm -- After more than 4 years, my SSPA was almost ready but still on the bench. Dario, IW2FZR pushed me to be QRV for the DUBUS 13 cm EME Contest -- if not to participate, to be at least be on. I did make it on by Sunday; and worked IW2FZR on CW and SSB and DB6NT for 2 QSOs. Later during the week, I added G4CCH on CW and SSB and PA3DZL, G3LTF and PA0PLY. It is a very nice EME band despite its difficult band plan. [Are you available for skeds? There should be an activity weekend (WE) this summer.]



Dish used by ON4BCB on 13 cm EME

OZ4MM: Stig gsvestergaard@gmail.com sends an update -- I had planned to be quite active in the 70 cm CW part of DUBUS Contest; but Murphy strikes again. When preparing the 70 cm setup Friday afternoon before the contest, I found the I couldn't use the dish controls at all! Early Saturday morning I found a burned

transformer! I replaced the transformer and could then use the dish; even with the then present high winds! It was great; FB echoes and great signals on CW. I worked DL6SH, G3LTF and PA5Y, who was an initial. Then my SSPA (R&S ex TV PA) went suddenly in error mode, and I had to turn it off. I couldn't find a quick solution. I had not been QRV in long time on 432, so I was quite disappointed as I had looked forward for joining the CW contest. I hopefully will do better in the 1296 part in April. The 70 cm SSPA is on the work bench, and I am trying to locate the problem.

PA0PLY: Jan pa0ply@pa0ply.nl reports on 13 cm in the DUBUS and ARI Contests -- After completing my new 2320 SSPA (Ericsson), I installed the 13cm equipment in the dish on 20 March in order to be ready to participate in the DUBUS Contest. In advance of the DUBUS and 13 cm SSB Funtest (24 March), I worked using Q65C unless noted F1RJ (12DB/17DB), IZ2DJP (16DB/17DB) for mixed initial #52*, DL6SH (7DB/9DB) and (559/559) on CW #53*, K3WM (519/519) CW #54* and IW2FZR (559/559) CW #55*. During the DUBUS Contest (25-26 March) I worked only CW and QSO'd OK1KKD, HB9Q, OH1LRY, ES5PC, OH2DG, SP7DCS (#56*), IW2FZR, DF3RU, DL6SH, IK3COJ, DB6NT, DL4DTU, K2UYH and G4CCH for a total of 14x14. I also heard OM6AA. After the contest I added on 29 March ON4BCB (599/579) CW #57* and on 30 March Q65C OK1USW (22DB/20DB) #58*. During the ARI Contest (1-2 April) I stayed on 13 cm but there was very little activity and I only worked OK1USW, IK3COJ and SP3XBO for total of 3. Outside the contest I tried unsuccessfully with 9A5AA due to heavy interference in RX at 9A5AA. I also had a partial with IW3ROW who uses a 1.9 m dish and 200 W. He was using a new setup and could not copy me, while I copied Mauro (22DB). Using my TS2000, I had the advantage of a Softrock receiver connected to the IF of the set. Particularly the weak CW signals could be traced easily and brought into the CW filter band for decoding. Decoding CW is not an easy job for me as I have a different hearing bandwidth and frequency. The CW filter does not allow to go down to say 300 Hz and peaks around 1000 Hz. I listen comfortable at a lower frequency and see in the waterfall of WSJTX that the tones are below the noise peaks of the CW filter. I wonder if there is a good solution for this phenomenon. [What you describe is not that unusual; especially when you get old]. In the meanwhile, I am working on a 13 cm set-up for PI9CAM.

PA3DZL: Jac pa3dzl@icloud.com was active in the 9 and 13 cm DUBUS CW Contest weekends -- In the 3400 contest, I was QRV for some hours and using CW worked on Saturday OK1CA, OH2DG, OK1KIR, DB6NT, G4CCH, ES5PC, DL6SH for initial (#) and G3LTF; and on Sunday DF3RU, SP3XBO and 9A5AA for a total of 11x9. On Sunday I also QSO'd DF3RU, G3LTF and G4CCH with very nice SSB signals! Signals on Sunday were stronger than Saturday. Unfortunately due to family commitments I could not be QRV during the NA-SA window, so missed some stations; nevertheless, it was great fun to be QRV on 9 cm off the

Moon. 9 cm is a great band for Moonbounce. I did not do as well in the 13 cm DUBUS weekend. Due to very high winds, I was only briefly QRV on Saturday. The WX was also bad in other parts of EU this day. The next day the WX was calm, so I was active most of the time on Sunday. Most signals were very strong, so it was great to make CW QSOs on this fantastic band. 13 cm is always a challenge due to the different allocations 2301, 2304, 2320 and 2400! On the other hand, this is also a lot of fun because it's a bit more complicated. I scored 26 QSOs and 26 mults; especially on Sunday there was a lot more activity. Worked TX 2320 - RX 2304 (XB) KL6M, K2UYH - big signal, K3WM and W5LUA. Worked on 2320 were OK1KKD, OH2DG, UA5Y, DB6NT, DL6SH, DF3RU, HB9Q - booming signal!, OH1LRY, IK3COJ, SP3XBO, ES5PC, OK2ULQ, DL4DTU, G4CCH, SP7DCS, IZ2DJP, PE1LWT, 9A5AA and VE6BGT for mixed initial #150* and our 4th band - also big signal. Worked TX 2320 - RX 2400 were JJ1NNJ, Heard were OZ5G and JA8ERE. IW2FZR was also copied, but I could not get his attention. It was all GREAT FUN. Hope to see you all off the Moon on 23 cm next month.

PI4GAC: Jac (PA3DZL) reports on the EME lecture and demonstration he put on from Gorinchem, NE -- The first part, the lecture on what is Moonbounce and how does it work was a great success. About 50 OMs were present, it was a mix of HAMs and other interested people. The second part was a livedemonstration of 432 EME with a "simple" portable station consisting of a single 25 el yagi and 350 W. I made 2 QSOs with UA3PTW and DL7APV. I also tried a CW QSO with DL9KR, but nil on my side. This was somewhat disappointing; Faraday did not cooperate, but also especially the amount of interference - QRM was a big problem. Quite a number of stations did receive our signal. I operated from a tennis court. I saw S3 to S5 interference caused by the lighting - gas discharge lamps! I had taken into account that there would be some QRM, but I did not expect anything this bad. Everyone seemed satisfied with all info on EME. There were definitely a few OMs that are going to be QRV off the Moon.

SP7DCS: Chris sp7dcs@wp.pl was active during the 13 cm DUBUS weekend -- I scored 14x14. QSO'd on 25 March were UA5Y, DL4DTU, DB6NT, DF3RU, DL6SH, OH1LRY, OM6AA, OK1KKD, PA0PLY, IW2FZR and HB9Q; and on 26 March PA3DZL, G4CCH and SP3XBO. I plan to be QRV again for the 1296 Contest in April.

VE6GBT: Skip macaulay.skip@gmail.com writes about his recent EME from VE6 land -- There was no activity here for the 70 cm DUBUS weekend as the temperatures here were around -20 degs C and I didn't have the 432 feed installed. A few days before the WX was reasonably warmer but then the winds picked up and I wasn't in the mood to freeze myself working on the dish. Next was the 9 cm weekend. I got everything installed, but had an issue with an SMA connection not

done up tight to the PA driver. I lacked a little drive, but I still had fun and made some contacts. 9 cm is a great band! QSO'd were OH2DG (569/579), G3LTF (579/579), WA6PY (569/569), KL6M (579/579), K2UYH (569/569), VE6TA (569/569), OK1CA (579/579), DL6SH (??/559), DF3RU (559/579), G3CCH (579/569) and ES5PC (579/569) for a total of 11x11. I was on for the 13 cm DUBUS event weekend next and worked IW2FZR (559/579), ES5PC (569/579), KL6M (579/579), K3WM (579/569), OH1LRY (579/579), G4CCH (579/579), PA3DZL (569/569), DB6NT (579/589), K2UYH (569/589), W5LUA (579/579), DL6SH (579/579), WA6PY (579/569) and KL6M (579/579) for a total of 8x8. I recorded some of the fun on video and uploaded it to my Nerd Channel, VE6BGT on YouTube for your entertainment!

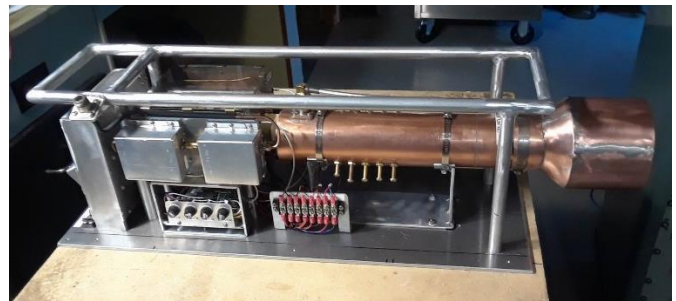

VE6BGT's 9 cm feed box

VK7ZBX: Richard vk7zbx@gmail.com updates us on the progress with his 3 cm EME station over the last couple of months -- I worked [using Q65D?] OE5VRL for a mixed initial on 23 March (#*). We tried the day before when Rudi was H pol and I was V pol without luck. The next day, he very kindly changed to V pol and we were successful. I worked 6 more stations in the ARI EME contest. This was my first time in this contest. I worked OK1KIR, OK1CA, OK2AQ, LZ4OC, DK4RC (#*) and IW2FZR on the 1st day. I couldn't be QRV on the second day. I had great fun indeed. I added on 7 April G0OLX (#*) - we had been trying for some time and it was a pleasure to finally make the contact; and on morning of 8 April CT2GUR - another great contact that we had been working to find a mutual window and experimenting with equipment to complete the contact. Over March/April, I also worked OZ1LPR with a massive signal on SSB that even with some 200 Hz of spreading I was able to make out my name, DJ7FJ, IK6CAK, LZ4OC and IZ4BFA. I'm very happy with my system consisting of a 1.8 m PF dish, Kuhne G4 Transverter, 20 W SSPA and RazTrak tracking.

W5LUA: Al w5lua@sbcglobal.net sends his impressive winter report -- With all the grid/state hopping going on last year and continuing this year, it has been a major struggle to make quick band changes on my 5 m dish. I have 4 bands permanently installed in my dish. I have the 3 cm feed in the center. The 13 cm feed is above the 3 cm feed. The 6 cm feed is to the left of the 3 cm feed. The 23 cm feed is to the right of the 3 cm feed. When I operate 9 cm, I place the 9 cm feed in the mouth of the 23 cm square septum feed. On 33 cm, I place the feed

in the center of the 23 cm feed and for 70 cm, I place the feed in the mouth of the 23 cm feed. I use a basic program written by K5GW that allows me to predict proper aiming on all bands with known offsets from the dish focal point. The program works well but I wish I could convert it to a Windows environment. At the moment I use a PC/laptop with 32 bit versions of Win 10. **To start off 2023**, I installed my 70 cm feed and worked using Q65B unless noted on 7/8 Jan VP8EME (new DXCC), OH3WW, DK3WG, N9XG, NH6Y, BV3CE (new DXCC), JF6CTK, and JH7OPT; on 28/29 Jan W5AFY, DL1VPL, RD3FD, DK0TE, HG5BMU (new DXCC), NN3Y, KF2T, EA5CJ, GM0HBK (new DXCC), DL7APV, N0AKC, DL7APV, PA2V and OH3AWW; on 4 Feb W2HRO, YL2GD, VP8EME, S51ZO, PA2V, and OH3AWW; on 25 Feb (432 DUBUS weekend) R50EME, OK1DFC, OK1VUM, SQ9CYD, DL7APV, F6GRB, LU8ENU, NN3Y and K2UYH; and then switched to CW for G3LTF, K2UYH and VE6TA; and on 26 Feb NH6Y, VK2CMP, VK3NX, PA0BAT and W5EME; then back to CW for UA3PTW and KL6M. Installed my feed for 33 cm and using Q65C worked on 27 Feb W2HRO, N1AV and K5DOG; on 1 March K5DOG and had a 1 way test with NX9O; and on 4/5 March KC0TYD, N0LNO and NX9O (Cedar Rapids group in EM84). Installed my 23 cm feed on 7/8 March and using Q65C worked KA6U (in EM56 KY), NX9O (in EM84 GA), EA8DBM, K5LA, CX2SC, N0CTR, SM6CKU, KD5FZX, W2ZQ, KB2SA, N0AKC, W5GLD, N1V (in BL11 HI), KA6U (in E M57 IL), VE3KRP, SM5DGX and N5TM. Switched back to 33 cm and using Q65C worked on 9 March N1V in Hi; on 11 March WA3RGQ and NX9O portable on dxpedition in New Mexico near 4 corners for State 30; and on 24/25 March AC0RA, W2HRO and K5DOG. Then switched to 13 cm for the DUBUS Contest and using CW worked on 26 March IW2FZR, PA3DZL (XB), DB6NT (XB), DL6SH (XB), VE6BGT, K2UYH, ES5PC, G4CCH (XB), WA6PY and KL6M for a total of 10x10. Back to 33 cm on 1 and 2 April (also ARI Contest weekend), I worked VE6TA, W2HRO, AC0RA, N1AV and VE4MA; and on 5 April using Q65C NX9O in CN84 Oregon for state #31.

K2UYH: I (Al) alkatz@tcnj.edu had a number of problems that limited my success, but could not help enjoying all the EME activity. I was QRV to check out my system for the 70 cm DUBUS Contest and QSO'd using Q65B on 25 Feb at 0238 VK2CMP (21DB/13DB) as I did not hear any CW at the time. In the CW contest I worked on 25 Feb at 1750 G3LTF (559/559), 1841 OE5JFL (569/569), 1847 SM6FHZ (559/559), 1922 OH2DG (589/579), 1930 VE6TA (569/569), 1944 PA3DZL (459/559), 1956 OH1LRY (559/559), 2007 PA5Y (569/559), 2017 DF3RU (569/569), 2033 DL7APV (589/579) and 2206 KL6M (569/O) and 2214 W5LUA (569/549), and 26 Feb at 1955 UA3PTW (589/589), 2003 G4RGK (569/569) and 2112 WA6PY (569/569) for a total of 15x15 – an improvement over last year of 3 QSOs. Unfortunately, I had to leave early for a family event. Out of the contest I worked using Q65B on 25 Feb at 2116 OK1VUM (8DB/11DB) for mixed initial #1095*, 2125 W5LUA (14DB/10DB) and 2132 GM0HBK (19DB/19DB) #1096*; and on 26 Feb at

2145 S51ZO (9DB/22DB) and 2158 LU8ENU (16DB/22DB) – operated by K2QFA. I was back on for the DUBUS 3400 Contest on 4 March to work using CW at 0110 G3LTF (569/589), 0124 WA6PY (569/579), 0131 KL6M (579/569), 0136 OH2DG (589/579), 0210 VE6TA (559/569) and 0216 VE6BGT (579/599); and on 5 March at 0034 G4CCH (559/569), 0051 9A5AA (559/559), 0059 OK1CA (579/579), 0104 ES5PC (579/589), 0112 WA9FWD (569/559), 0126 DL6SH (569/579) and 0240 DF3RU (569/579) for a score of 13x12. NE2U joined me operating during part of this contest. I was on late for the 13 cm SSB Funtest due to a number of frustrating problems with the rotator and then my preamp. I had excellent SSB echoes but there was no one to work by the time I was QRV. The DUBUS 13 cm Contest was 25 March and I worked at 1658 K3WM (569/589), 1716 DL4DTU (559/559), 1722 DB6NT (569/569), 1731 G3LTF (579/569) XB, 1740 OH1LRY (569/579) XB, 1810 ES5PC (569/579), 1835 OK1KKD (569/579), 1838 PA3DZL (579/579) XB, 1850 G4CCH (559/579) XB, 2000 DF3RU (559/559) XB and 2015 KL6M (559/559); and on 26 March at 1738 IW2FZR (569/579), 1817 VE6BGT (559/559) XB!, 1827 PA0PLY (569/599), 1913 W5LUA (569/579), 1930 DL6SH (579/589) and 2030 WA6PY (569/579) for a total of 17X17. It was a mistake to not operate during the JAVK window. I did not expect activity. I did not plan to operate the ARI Contest due to various conflicts, but was able to be QRV on 1 April on 1296 using Q65C and QSO'd at 0014 KA6U (10DB/10DB) for mixed initial #757*, 0019 PA3FXB (6DB/5DB), 0030 LU8ENU (16DB/14DB), 0042 K2BSA (4DB/8DB), 0100 KN0WS (16DB/17DB), 0109 W2LPL (18DB/16DB), 0117 IQ2DB (9DB/14DB), 0130 N5BF (9DB/9DB) and 0145 W5AFY (8DB/6DB) for 9 QSOs. I plan to be QRV for the 1296 VK3UM Memorial contest on 22/23 April. I tried on 902 with N1V in Hi several times. This time I copied them well, but they nor anyone else could copy us. I still need to trouble shoot the TX. It seems to be putting out plenty of power. I also tried with the CY0S dxpedition. They were very cooperative considering my limited operating time and window. They hear me FB, I was never able to detect their signal – I thank them for the try.

LOGGER/NET NEWS: DU3T in addition to 23 cm is working on 13 cm EME. Ron hopes to be QRV on 13 cm CW/SSB soon with his 4.6 m dish and 1 kW. Write him for skeds at ronbpc@freenet.de. **K0PRT's** group have announced they will be operating from their CO QTH with their 60' dish in the DUBUS 1296 CW EME Contest on 22-23 April. **IZ1ANT** is working on becoming QRV on 13 cm EME. He plans to mount an 8' wood/grid foldable stressed dish on my balcony for 13 cm operation and is looking for someone to test RX with. I will initially use manual aiming at Moon. If interested in helping contact Aldo at iz1ant@gmail.com. **OK2PE** in the 1296 Funtest back in Feb scored 6 SSB QSOs in in 3 sectors for 3,600 points with DG5CST, OK2DL, DL6SH, I1NDP, IK1FJI and G3LTF. **PA3CSG** is dismantling his 8.5 m mesh dish. Geert will focus on 10 GHz EME in the future. **GW4ZHI** has increased his capability on 70 cm EME by putting together an 8 x 12 yagi array. Bryn is looking

forward to making many more contacts and can be reached for skeds at brynhp@icloud.com.



GW4ZHI's new 8 x 12 yagi 432 array

FOR SALE: EA8DMF has for sale near complete 23 cm 500 W F5JWF PA using 4x MRFE6S 9160. Complete kit. If interested contact ea8dmf@moon-net.eu. **YU1CF** reports having for sale the longest commercially available 1296 yagi, PA1296-70-6AUT – see <https://youtu.be/1rtXJpSVUT4>. If interested contact Goran at <http://www.antennas-amplifiers.com>. **SM5GDJ** has still for sale several 23cm items, more at: <https://www.sm5gdj.se/443659149.html>. **OK1TEH** still has for sale OK1FPC's cheap 3 and 6 cm transverters; see for full description at https://ok2kkw.com/next/ok1fpc_10g.pdf. Also OK1FPC's 250 mW in and 4.5 W out SSPAs (at 1 dB compression). Price on request but very competitive. If interested email ok1teh@seznam.cz.

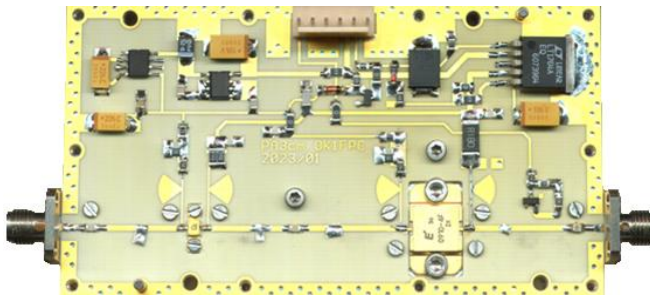

4.5 W 10 GHz SSPA (comes in robust milled box)

OK1TEH has for pick-up a 3 m (to 24 GHz) solid robust dish. Its weight is around 70 kg, so it can be easily loaded by 2 persons on a trailer is F/D 0.354. For more info contact ok1teh@seznam.cz.



OK1TEH - for sale 3 m solid dish good to 24 GHz

RADIO-ASTRONOMY CORNER: Hi readers. What's happen during last few month? 1) is the new design of the Next Generation Very Large Array (ngVLA). The prototype antenna has passed an intensive, five-day review, clearing the way to begin manufacturing the antenna. The review in Wiesbaden, Germany was attended by scientists and engineers from the National Science Foundation (NSF), the NSF's National Radio Astronomy Observatory (NRAO), and Mtex antenna technology GmbH, the firm contracted to develop the design and produce the prototype.

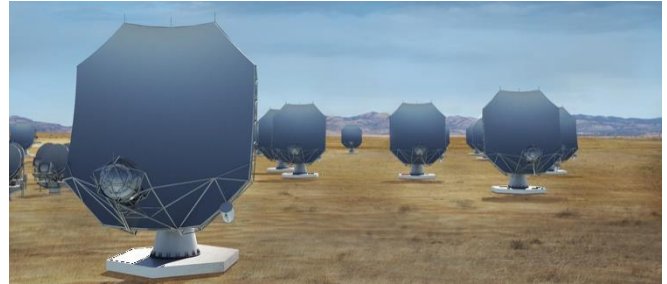

The ngVLA, has 263 dishes distributed across North America. It will be one of the next generation of cutting-edge astronomical observatories. It will have sensitivity to detect faint objects and resolving power more than 10 times greater than the current VLA. NRAO and Mtex signed a contract in mid-2021 for the design of 244, 18-m offset Gregorian antennas and production of a prototype with good surface up to 116 GHz. More can be seen at <https://public.nrao.edu/news/contractor-antenna-development/>. 2) **SPLAT 150 GHz radio telescope at South Pole** See <https://arxiv.org/pdf/2207.10012.pdf>.

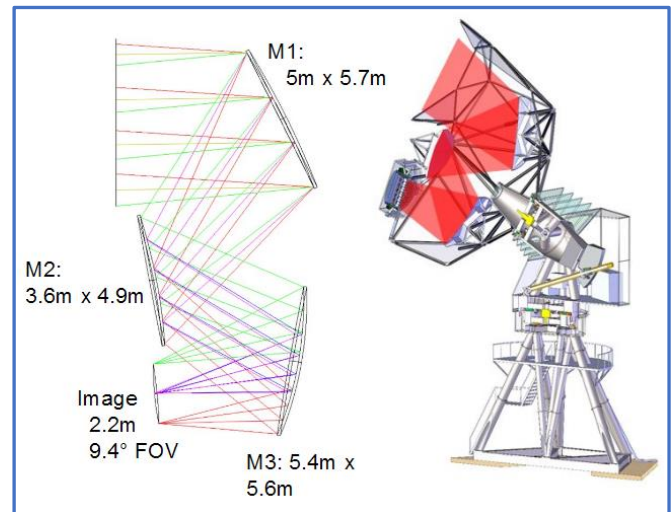

Related to the latest radio-telescope; sometimes you hear in news that China has developed some of the largest telescopes for Solar radioastronomy. I find much more interesting that the upcoming SPLAT telescope to be located at the South pole under the project called CMB-S4 has an 5 m aperture giving a 1.7 arcmin beam width at 150 GHz. It together with CHLAT in Chile will be used for observation of the polarization of the Relict background radiation, which was originated some 400, 000 years after the Big Bang. The radiation of millimeter wavelengths has too low an energy to measure

compared to visible light. The photo-effect of a semiconductor detector can be used, but it has too high frequency to amplify with a transistor amplifier. Therefore, the relict radiation detector consists of several elements. Millimeter waves from the optical system first fall on horn antennas, where the size of the signal in each of the horns provides spatial information. From the horns the signals are separated into two signals with each having perpendicular polarization. This will enable information about the polarization of the signal. From the hub, the signal is brought to the TES (Transition Edge Sensor) sensors, which detect microwave radiation. TES sensors operate at 0.1 hp, just below the critical temperature of the transition between superconducting and a non-repair condition. If the microwave is absorbed in the TES sensor, the sensor warms up above the critical temperature to increase the electrical resistance and change the electrical current. However, the change in current is not great and cannot be measured by a conventional ammeter. The current is measured here through the magnetic field with a quantum magnetometer Squid. Furthermore, the signal emerges from the cryogenic part and is processed by relatively common electronics. The CMB-S4 detector will have approximately half a million measuring channels. CMB-S4; however, is not only about detection of B modes in polarization of relict radiation. In the detailed microwave image of the universe, it is possible to recognize the effects of gravitational lenses that cause distant piles of galaxies. In this way, it will be possible to map the distribution of matter in the universe more precisely and learn more about the growth of a large-scale structure. The spectrum of temperature fluctuations can also reveal more information about the weights of neutrinos. CMB-S4 data can also bring some surprises in the form of discovery of topological defects. It is likely that we will hear about the CMB-S4 project much more often in the near future. See <https://indico.cmb-s4.org/event/3/contributions/111/attachments/81/157/2021-03-10-SPLAT-Update.pdf> and <https://indico.cmb-s4.org/event/3/contributions/69/attachments/90/169/LAT%20Plenary%2020210310.pdf>.

3) Venus at 47 GHz by hams - Iban (EB3FRN) and José (EA3HMJ) on 7 April performed the 1st detection of planet Venus at 47 GHz using José's Kathrein CAS120 dish! On 8 April, Miguel (CT1BYM) confirmed their reception with similar results. Both stations get over 0.020 dB of SN with BW = 10 MHz and Tint = 10 s. They report the planet is visible even with a Tint = 2 s. With this dish, we are getting every day > 11 dB from the Sun and about 1.6 dB of Moon noise. More details and study will follow very soon!

4) Artemis II – first hams around the Moon in 2024 - NASA Names Three Hams for Artemis II Moon Mission Crew - Their assignments are as follows: Commander Reid Wiseman, KF5LKT; Pilot Victor Glover, KI5BKC; Mission Specialist 1 Christina Hammock Koch; and Mission Specialist 2 Jeremy Hansen, KF5LKU. Koch had planned to study and take her amateur license exam in 2019, but her flight was suddenly rescheduled 6 months earlier than originally planned. She had to immediately begin preparing for her flight instead of studying. NASA

astronaut Reid Wiseman KF5LKT is well known for his operating as NA1SS from the International Space Station during the 2014 ARRL Field Day contest.



TECHNICAL: A View of G4RFR's 10 GHz EME WSJT-X Reports Compiled by G3YGF - This analysis was suggested by M5RAO of the FRARS group. Since Q65 generates a signal report automatically, here are plots of all the stations that we have worked or have heard us on Q65. (If you only appear on one plot, it is because you only heard us, or we do not know your TX EIRP.

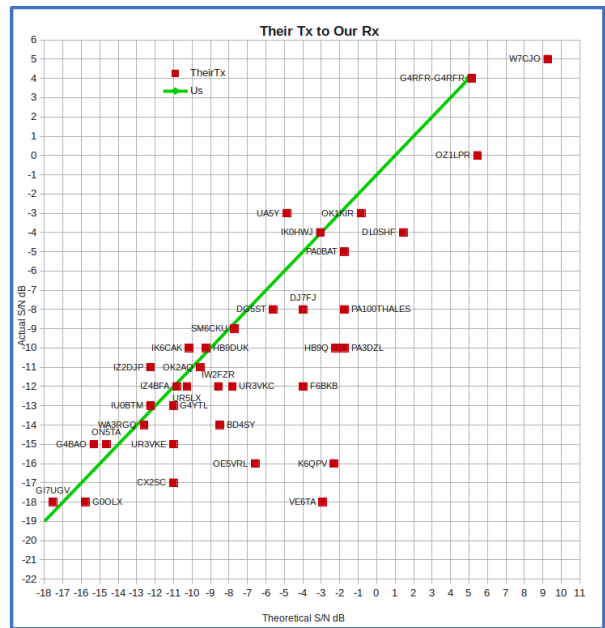

This plot compares actual WSJT-X SNR reports, with calculated SNR derived from TX power, TX and RX dish sizes obtained from HB9Q, nominal Rx NF, BW (2500 Hz) and path loss (minimum 288 dB). The receive temperatures of other stations have been assumed to be 300 K. Polarization loss, if present, should be the same for both stations. Thus, if the data were perfect, all the points would lie on a straight line at 45 degrees. The Green lines are plots of our signals, received on our system for comparison, based on the strength, we hear DL0SHF running 33 W. Points to the upper/left of the line are overestimating the signal strength; points to the lower/right are underestimating it.

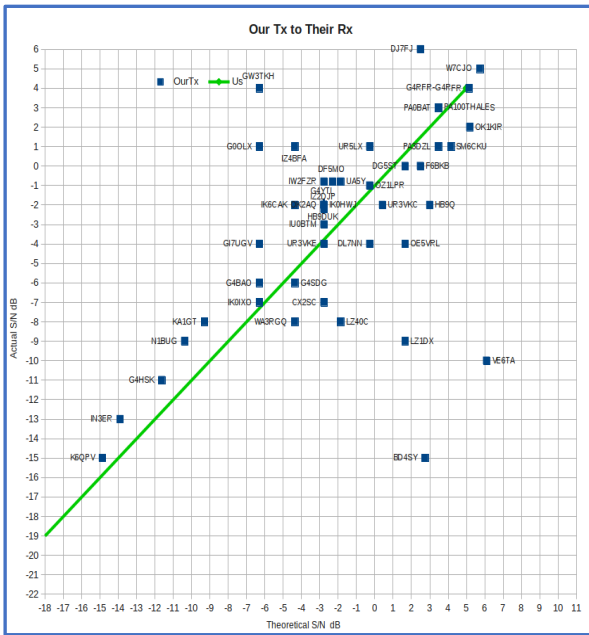

The first plot is "Their TX to Our RX" against the theoretical SNR. The plot shows a clear upper bound on the received SNR, and suggests that the maximum value of EIRPs of other stations are reasonably accurate. The second plot is "Our TX to their RX" against the theoretical SNR. There is a larger scatter on this one, and it suggests given that our TX is fairly well characterized and the other station's dish gain also occurs in the first plot, maybe other people's WSJT reports or noise levels are more variable than we thought. On the plots, we/us etc. refers to G4RFR.

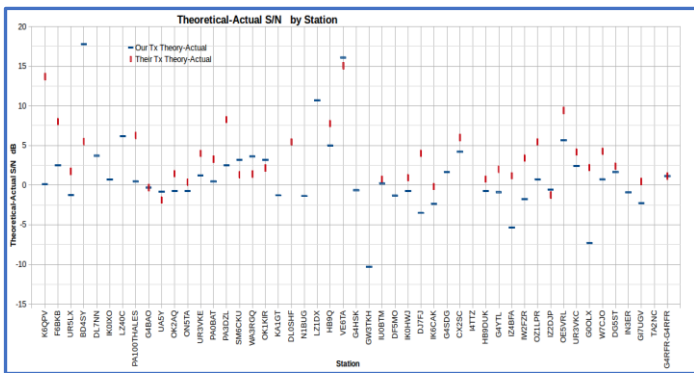

The third plot is "Theoretical SNR - Actual SNR for each direction by station". This is the same data as before, plotted by station (in order of date worked, left to right). Most stations seem to be around the +2 dB level, and so maybe the theoretical SNR is a bit high. Reports have all been taken from the strongest transmission received, some over several QSOs, so most errors in dish pointing, and WSJT reporting on the first transmission heard, have been removed. It should be good to +/-1 dB or so, but some errors will remain. The theoretical SNR should be good to a couple of dB. Stations with a 10 m dish, (HB9Q and VE6TA) have been reduced to 5 m, as we have assumed the extra gain will not increase the signal strength much. The effective dish size of stations operating Circular

Polarization (eg HB9Q) has been reduced by 3 dB to allow for the loss between CP and Linear, as the loss will affect both Tx and Rx. Some stations, eg. VE6TA, are on one side of the line with a similar offset in both plots 1 and 2; others, eg PA0THALES have a different offset in the two plots. Four or five stand out as significantly different. I would be interested to receive any updates to details put on HB9Q, or thoughts on the reason for these differences – eg. dish gain, polarization loss or noise temperature.

FINAL: There was disturbing news [DUBUS 1/2023] that OEs will lose their 1296 high power license privileges in 2025. Output power will be limited to only 10 W. It is still not clear how definite is this decision or what exceptions might be possible. It is certainly of great concern.

► **47 GHz EME Beacon:** DK7LJ runs the DL7SHF EME Beacons for 10 and 24 GHz. Per writes – I have built a new tracking system for 47 GHz with an accuracy of 1/100 of a deg for a 3 m dish, which was built for 38 GHz. W1GHZ helped me with the construction of a Cassegrain system for this dish. My first test on RX is done and giving 10 dB of Sun noise. There is still work to done. Worldwide there are about 5-8 stations who are trying to optimize their systems for 47 GHz. This beacon would be very helpful to them. I do not see any possibility of using a solid state PA for TX. Thus, I am searching for a used TWT. The PSU, I can do by myself. **Does anyone have any connections that could help me?**

► **The 10 GHz beacon** is repaired, up and running well and available for testing.

► **Please start planning to be in Trenton for EME 2024 in Aug 2024. We should have the dates set by the end of May.** The first organizing/planning committee meeting will be by Zoom starting at 12 noon ET on Wednesday 17 May. (If anyone sees a problem with this date and time, please let me know ASAP. (know it will be a bit early in Asia. I plan to send out invitations in the next week. Committee members from all around the World will be invited to join. **If you are interested in being on the EME2024 Committee, please let me know and I will send you connect information.**

► **DL1SUN SK:** Norbert was a very well know VHF, UHF and SHF DX and contest operator. He made many EME contacts as well. He was an especially close friend of OK1TEH. Matej asked that we include the beautiful piece on his life by DL1SUZ, at the end of this NL. We have lost so many this year. For Whom the Bell Tolls; It Tolls for Thee. May Norbert, Simon and all our SK friends Rest in Peace.

► The reports this month seem a little down from the norm. The last couple of months have been particularly busy for Matej and I. But we now seem to be catching up. Please keep the activity reports and tech info

coming. We will be looking for you off the Moon – especially in the upcoming VK3UM Memorial 1296 Contest and in May for the 6 cm CW DUBUS Contests. Have a terrific EME DX filled time on EME. **73, AI – K2UYH and Matej – OK1TEH**

DL1SUZ wrote: Hello dear SHF community, I must



bring you the sad message that Norbert, DL1SUN, on Tuesday, the 3rd Jan, is now a silent key. Norbert was one of the most active contesters in the 2 m-24 GHz range here in the north until his serious stroke in 2014. His good placements in the VHF contest cup, which he won in 2010, testify to this. From 2012 Norbert was

using a group of 4 x short yagies on the 2 m band and also active on EME. Here he was able to record about 350 initials until 2014. We have in the many years of our friendship (and that goes back to the sandbox) very much together and could and were able to push each other forward again and again. Since we appeared at many amateur radio activities, also very often together and perhaps also because of the similarity of our calls, Peter, DL4BBU, gave us the nickname "GHz twins from Mecklenburg-Vorpommern" at a GHz meeting in Dorsten. Due to the limitations after his illness in 2014, Norbert could no longer operate his quite complex station. In 2020, we installed a kW station at Norbert's place with the help of his colleagues. And with the help of the FT8 operating mode FT8, despite his limitations, he could be QRV again and logged over 1000 QSOs until his SK. He says then and always that this was for him the EME of the little man. Now his call is silenced forever. Rest in peace dear Norbert!